

IMPROVEMENT OF THE BARGE HULL BY OPTIMIZATION OF ITS RIGIDITY PARAMETERS

Gornostajev D., PhD.¹, Assoc. Prof. Aryassov G. PhD², Assoc. Prof. Penkov I. PhD²
 BLRT Group, Marketex Marine OU, Estonia¹
 Department of Mechatronics – Tallinn University of Technology, Estonia²
 dmitri.gornostajev@mail.ee, gennadi.arjassov@ttu.ee, igor.penkov@ttu.ee

Abstract: The article discusses optimization of barge hull by decreasing of its mass parameters by changing of thickness of the plates. The fish-feeding barges are usually used in calm water and in this case it is possible to consider only static loads applied on the barge hull.

There are many calculation methods for determining stress and deflections in the thin plates. A lot of them are using uniformly distributed load and constant thickness of the plate. In real conditions, a hydrostatic pressure is applied on the barge hull. In this research, we consider a calculation method of thin plates taking into account variable thickness of the plates and non-uniformly load. In addition, we try to show by experiments and FEM analysis the possibility to use variable thickness of barge hull in building of fish-feeding barges.

Keywords: BARGE HULL, BENDING OF PLATES, VARIABLE STIFFNESS, DEFLECTION

1. Introduction

Today’s fish farming industry is growing very fast due to increased fish consumption in the world. The market in Norway is very stable and has been growing very well. Fish farmer companies are investing increasingly in their business. Those developments are required to open more slots in the fjords, to establish new fish feeding centers, to fulfill the requirement of the consumers. Due to limitations in the law, farmers need to place fish farms farther away from the shore. The requirement to be taken into consideration is the load capacity of the barge and store room size. Those parameters are very important because of remote location of the barges from the shore and limitation of availability service ships who supply the feed for the fish. In other words, the barges need to be lighter in weight and have more capacity to meet the requirements of consumers.

the barge and the store room size. Those parameters are very important because of offshore location of the barge and limitations of availability of service ships who supply the feed for the fish.

2. Overview of Methods for Plate Calculation and Comparison of the Results

As soon as the barge is in calm water, the dynamic forces are not present and in this case it is possible to consider only static loads applied on the barge hull. The uniformly distributed pressure is located on the bottom plate and the hydrostatic pressure is placed on the sides of the barge.

There are a lot different methods for calculation of plate bending:

- a) Navier’ method [3],
- b) Levy solution [3],
- c) collocation method [3],
- d) Kantorovits-Vlassov method [3],
- e) grid method [4],
- f) plate calculations by FEM [5].

In order to determine which of the methods suits best for plate calculation and is closer to the real solution, comparison of the deviations of all the methods is essential. The data of all deviations for plates loaded by a distributed load are shown in Table 1.

Table 1. Deviations of all methods from the real solution for the distributed load, %.

Parameters	Method					
	Navier'	Levy	collocation	Kant.-Vlassov	grid	FEM
Shearing forces	18	17	11	14	22	14
Vertical reactions	15	15	11	15	20	15
Deflection	0	0.5	0	0	0.7	7
Bending moments	2	2	2	0.5	4.6	6.5

Table 1 demonstrates that the Navier’, the collocation and the Kantorovits-Vlassov methods have the smallest deviation from the real solution. The deviation for the deflection is equal to zero, which means that the solution exact in terms of the real solution for calculations with certain boundary conditions. Next in ranking are the Levy and the grid methods with deviations for the deflection equal to 0.5 % and 0.7 %, accordingly. The FEM method appears to have the largest deviation, accounting for 7 %. In summary, all the methods can be used for plate calculation taking into account the boundary conditions and deviations for bending moments, shearing



a)



b)

Fig. 1. Fish-feeding barge (a) and its cross-section in silos bunker (b) [1, 2].

Some vessels as barges (Fig.1) have no to move by their own force and have to be towed by other vessels such as tugboats. This study concentrates on fish feeding barges, the most useful and fast developing type of vessels in the fish feeding industry. Focus will be on the forces having impact on the hull of the barge. The requirement to be taken into consideration is the load capacity of

forces and vertical reactions, if necessary. If we take all the parameters into consideration, we can conclude that the most suitable method for plate calculation is the FEM method, the deviations of which are not the smallest in terms of all the parameters, such as the deflection, the bending moments, the shearing forces and the vertical reactions. However, taking into consideration the boundary conditions, it is most suitable for hull calculations.

Table 2 presents the results of deviations for the plates loaded by the hydrostatic pressure.

Table 2. Deviations of all methods from the real solution for the hydrostatic pressure, %.

Parameters	Method					
	Navier'	Levy	collocation	Kant.-Vlassov	grid	FEM
Shearing forces	19	18.5	12	15	24	16
Vertical reactions	16.3	17	12	16.5	21	17
Deflection	0.8	1.8	0.5	0.5	1.3	8.5
Bending moments	2.9	3.1	2.6	1.2	5.5	7.5

3. Calculation of Plates with Variable Thickness

All methods mentioned above use plates with constant thickness. In case of fish-feeding barges more optimal is to consider hulls made of plates with variable thickness according to hydrostatic pressure applied on the side of the barge. Taking into account changing in thickness of the hull plates the calculation procedure will be more complex. The calculation scheme is presented in Fig. 2.

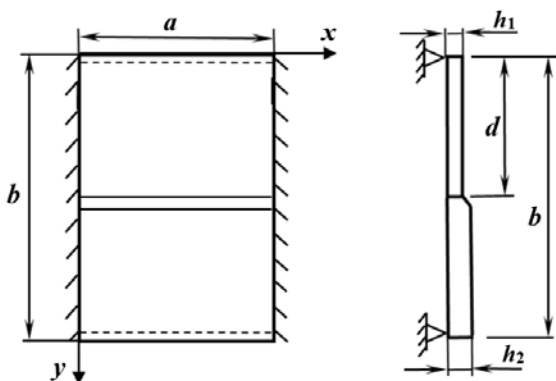

Fig. 2. Rectangular plate with variable thicknesses.

The theoretical background of this method of plate calculation and equations of calculation are shown in our work [6]. The final equations for calculation of plate deflections can be presented as follow

$$w(x, y) = (\bar{Y}(y) - \tilde{Y}_r(y)) \left(1 - \frac{x^2}{a^2}\right)^2 \quad (1)$$

The parameters $\bar{Y}(y)$ and $\tilde{Y}_r(y)$ for uniformly distributed pressure and for hydrostatic pressure are given in the work [6].

In order to solve the equations and to obtain the numerical results of deflection the Matlab program is used. The results are presented by the curve of deflection for all four calculation cases:

- 1 – the plate with constant thickness loaded by the uniformly distributed load,
- 2 – the plate with constant thickness loaded by the hydrostatic pressure,
- 3 – the plate with variable thicknesses loaded by the uniformly

distributed load,

- 4 – the plate with variable thicknesses loaded by the hydrostatic pressure.

The load were 6 kPa, 12 kPa, 18 kPa and 24 kPa for the uniformly distributed load and for the hydrostatic pressure. The calculations were made for plates with constant (8 mm) and variable (6 mm and 8 mm) thickness with dimensions of 180 mm in width and 400 mm in length. Steel grade NVA with yield stress 235 N/mm² is used.

The calculation results for case 4 (plate with variable thicknesses loaded by the hydrostatic pressure) are shown in Fig. 3 and for all calculation cases in Table 3.

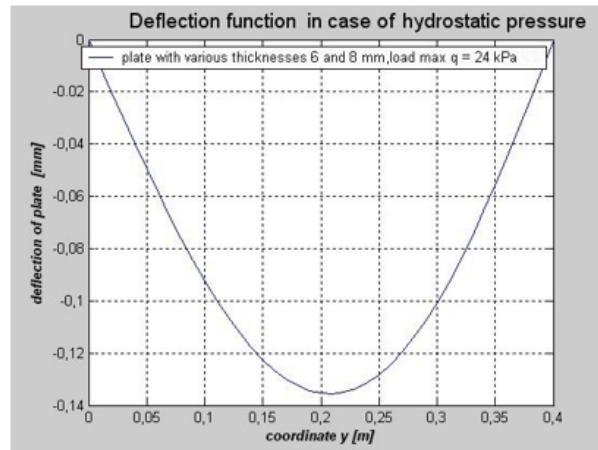

Fig. 3. Curve of deflection for the plate with variable thicknesses of 6 mm and 8 mm loaded by the hydrostatic pressure 24 kPa.

Table 3. Maximum deflections of the plates, mm.

Case of calculation	Load, kPa			
	6	12	18	24
1	0.110	0.240	0.370	0.490
2	0.022	0.049	0.072	0.099
3	0.160	0.320	0.510	0.690
4	0.031	0.062	0.093	0.133

From the Table 3 it is possible to see that deflections of the barge sides under hydrostatic pressure are about five times less than the theoretical calculations with uniformly distributed load. Values of deflections of plates with variable thickness increase about 40 % in comparison to deflections of plates with constant thickness but even in this case they are about three times less than in the case with constant thickness and uniformly load.

4. Experiments and FEM calculations

To check results obtained by calculations on base of proposed theoretical method were made experimental tests and extra FEM calculations. During the tests was used a standard tensile test machine with additional equipment. Schemes of loading, methodology and results of experiments are described in work [7]. FEM calculations were made with Solid Works Cosmos program and the results are presented in Figs. 4 and 5.

First, calculations were made for the plate with a constant thickness of 8 mm with dimensions 180 mm in width and 400 mm in length under a distributed load and under the hydrostatic pressure (Fig. 4) with maximum value of load equal to 24 kPa. In these cases of loading the maximum values of stress are 36 N/mm² and 9 N/mm² accordingly and the maximum deflections are 0.47 mm and 0.09 mm accordingly to load cases 1 and 2. The results are very

close to the results obtained by calculation method proposed by us and to the experimental results.

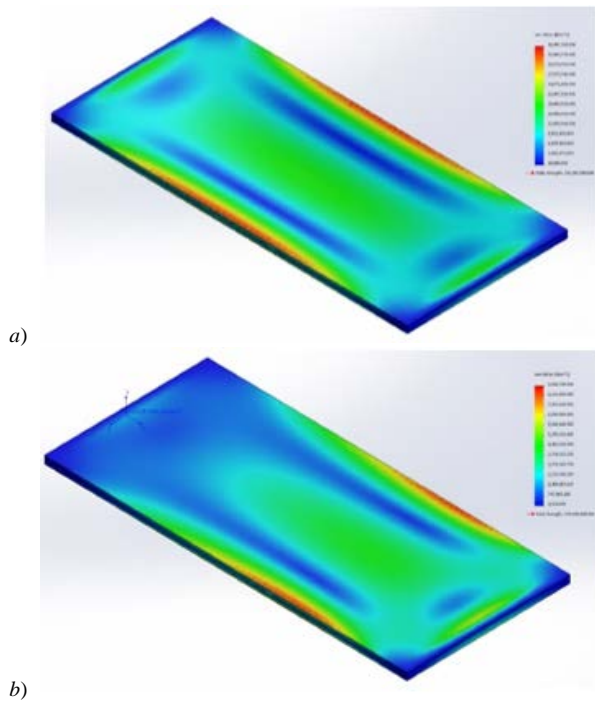

Fig. 4. Stress simulation and the results for the plate with a constant thickness of 8 mm under the uniformly distributed load (a) and the hydrostatic pressure (b) of 24 kPa.

The same calculation are required for the plates with variable thicknesses of 6 mm and 8 mm. The results are presented in Fig. 5. The maximum stress is equal to 54 N/mm² for uniformly load and to 10.5 N/mm² for hydrostatic load. The maximum deflections are equal to 0.9 mm and 0.14 mm accordingly.

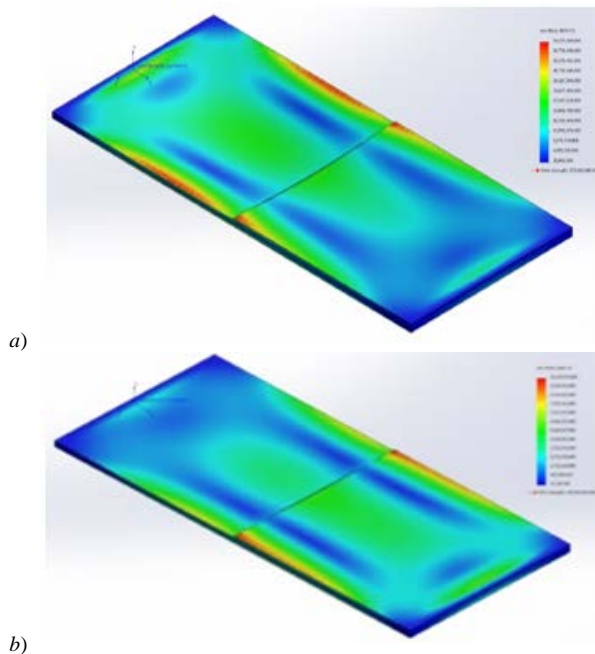

Fig. 5. Stress simulation and the results for the plate with variable thicknesses of 6 mm and 8 mm under the uniformly distributed load (a) and the hydrostatic pressure (b) of 24 kPa

The obtained results mean that at loading by the hydrostatic pressure it is possible to use thinner plate thickness and at the same time keep the strength. As a result, we have decreased the weight of the plate, which is a very good result regarding the weight of barges and ships.

The results from all the calculations have to be compared. First, let us to compare the experimental and the FEM results. Fig. 6 shows the deflections of the plate with a constant thickness of 8 mm under uniformly distributed load. As the chart shows, the results are very similar.

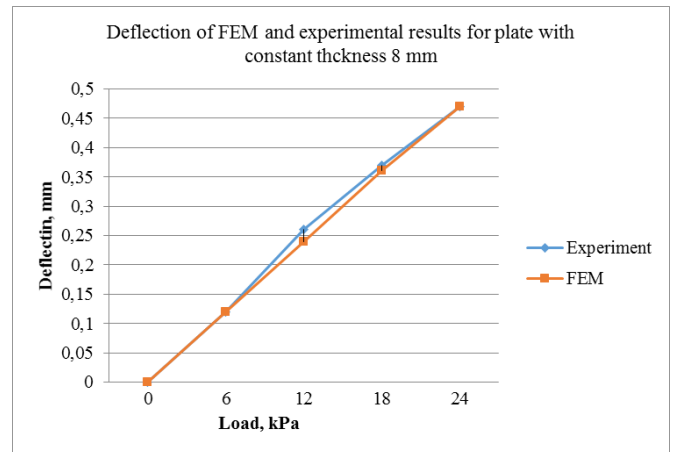

Fig. 6. Deflection for the plate with a constant thickness of 8 mm under uniformly distributed load from the experiments and the FEM calculations.

In order to simplify it, the results of the deflections achieved for the plate with a constant thickness of 8 mm are shown in Table 4.

Table 4. Deflection for the plate with a constant thickness of 8 mm under uniformly distributed load at different methods, mm.

Method	Load, kPa			
	6	12	18	24
Proposed	0.11	0.24	0.37	0.49
Experiment	0.12	0.26	0.37	0.47
FEM	0.12	0.24	0.36	0.47

The procedure for the plate with variable thicknesses will be the same as with the plate with constant thickness. Figure 7 shows the deflections of the plate with variable thicknesses of 6 mm and 8 mm under a distributed load found by the experimental and the FEM method.

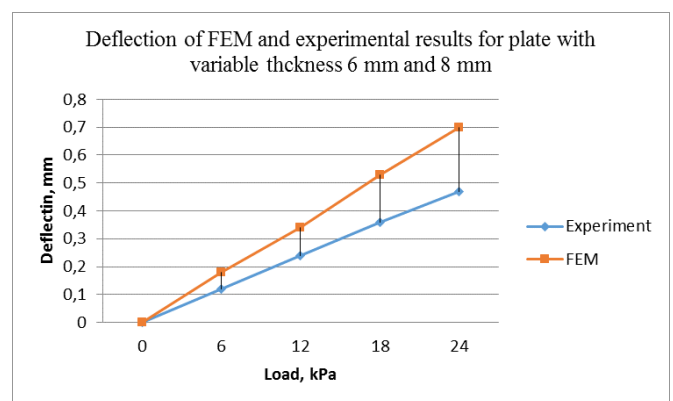

Fig. 7. Deflection for the plate with variable thicknesses of 6 and 8 mm under a distributed load from the experiments and the FEM calculations.

It is also possible to obtain the results of deflection found by all the methods for the plate with variable thickness under a distributed load. The results are presented in Table 5.

Figure 8 shows the deflections of the plate with a constant thickness of 8 mm loaded by the hydrostatic pressure obtained by the proposed calculation method and by the FEM calculations.

Table 5. Deflection for the plate with variable thicknesses of 6 mm and 8 mm under a distributed load obtained by different methods, mm.

Method	Load, kPa			
	6	12	18	24
Proposed	0.16	0.32	0.51	0.69
Experiment	0.15	0.29	0.44	0.59
FEM	0.18	0.34	0.53	0.70

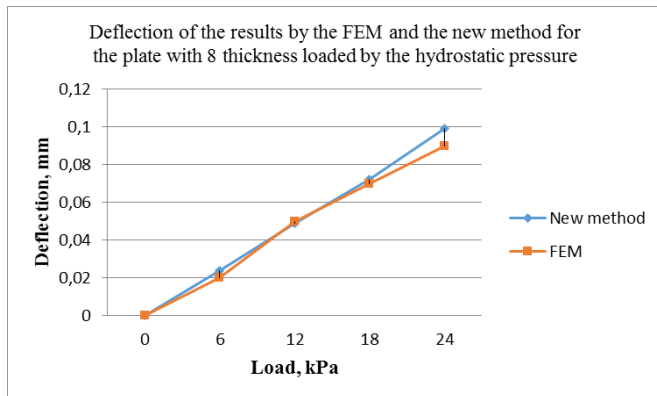

Fig. 8. Deflection for the plate with 8 mm constant thickness loaded by the hydrostatic pressure from the new proposed calculation method and the FEM calculations.

The same procedure as was used for the constant plate will be applied to the plate with variable thicknesses. Figure 9 shows the deflections of the plate with variable thicknesses of 6 mm and 8 mm loaded by the hydrostatic pressure.

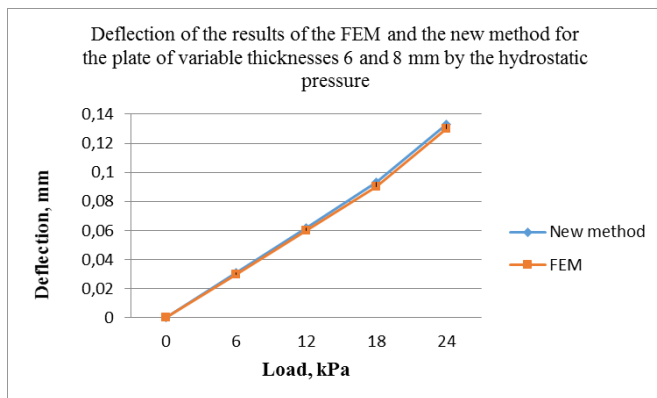

Fig. 9. Deflection for the plate with variable thicknesses of 6 and 8 mm loaded by the hydrostatic pressure from the proposed method and the FEM calculations.

Conclusions

A new method for the calculation of plates with variable thicknesses is proposed. The results of the new method are close to the results by FEM calculations. The deviations are in the range from 0 to 11 % to compare with FEM results. The experimental results are also close to the results of the proposed calculation method. The maximum deviation is in the range from 0 to 17 %. The new method enables the weight of the plates on the barge to be decreased by using plates with variable thicknesses. At the same time, the strength requirements are satisfied. The method can be used as a basis for the development of an algorithm for program calculations of plate thickness. Implementation of the new method could give an economical effect on the cost of the barge or another object.

Acknowledgments

This research work has been supported by Department of Mechatronics, Tallinn University of Technology and by Estonian Archimedes Foundation (project „Doctoral School of Energy and Geotechnology“).

References

1. Fish farming in Norway. <http://www.ocea.no/ocea/>. 06.2014.
2. Fish farming in Norway. <http://www.akvagrroup.com/home>. 06.2014.
3. Timoshenko S., Theory of Plates and Shells, McCraw-Hill Bool Company, Inc., New-York, 1990.
4. Biderman V., Mechanic of thin plates, Moscow, 1987.
5. Szilard R., Finite Calculation Methods in Structural Mechanics, Vol. 2: Surface Structures, Wilhelm Ernst & Sohn, Berlin, 2004.
6. Gornostajev D., Aryassov G., Penkov I., Calculation Method for Optimization of Barge Hull, International Review of Mechanical Engineering, in Press.
7. Gornostajev D., Development of the Calculation Method of Barge Hull, PhD Thesis, Tallinn University of Technology Press, Estonia.