

COMPARISON OF THE FRICTION COEFFICIENT FOR SELECTED CAR SUSPENSIONS ELEMENTS

Ph.D. Eng. Wozniak M¹, Prof. M.Sc. Ozuna G.², Ph.D. Eng. De La Fuente P.³, M.Sc. Eng. Jozwiak P.¹, Prof. M.Sc. Pawelski Z.¹
 Department of Vehicles and Fundamentals of Machine Design – Lodz University of Technology, Poland
 Department of Industrial Engineering and Systems - University of Sonora, Mexico²
 Department of Fluid-Energy Machines - Ruhr-University Bochum, Germany³

marek.wozniak.1@p.lodz.pl, gozuna@industrial.uson.mx, pablo.delafuente@rub.de, jozwiak.piotr@gazeta.pl, pawelski@p.lodz.pl

Abstract: This paper presents values comparison of friction coefficient inside ball joints depending course given by the vehicle, period of exploitation and the vehicle brand. Friction coefficient were defined on the contact surface between steel ball joint pin and the ball joint seat made from plastic covered by PTFE. For the selected working pair of the elements comparison of friction coefficient in load function are done. The preform of the measurements methodology and the test bench are additional show in the paper.

Keywords: BALL JOINT, FRICTION COEFFICIENT, PIVOTING FRICTION, STRING.

1. Introduction

The set of phenomenon's in the contact area between two bodies in the rest, or moving towards oneself friction is called. As a result of these phenomena's resistance of motion are arises. A lot of kinds of the friction are distinguish. It is possible to distinguish diversity of friction conditions types inside the working pairs (figure 1).

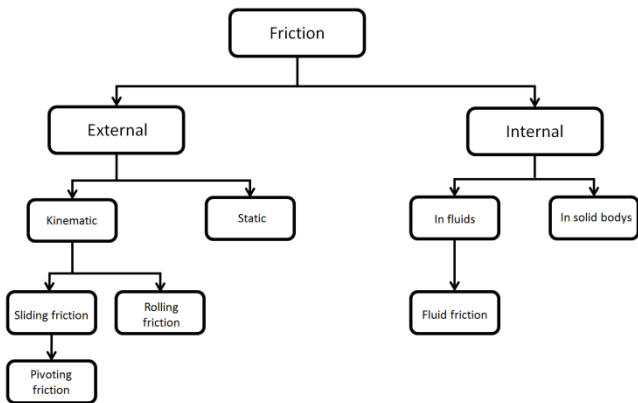

Fig. 1 Types of friction.

The machines constructors try to eliminate friction dry, replacing it more advantageous fluid friction. Because co-operating surfaces are not ideally smooth, on the top of irregularity of surface could be condition of dry or boundary friction and cavities are fill by lubricant. In such conditions the friction in the rough contact surfaces is the mixed friction.

2. The pivoting friction

One with special cases kinetic sliding friction is pivoting friction.

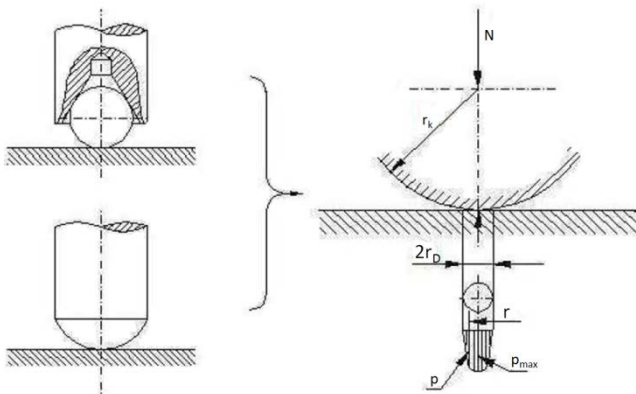

Fig. 2 Model of the bearing type spherical cap on plate; p - Hertz pressure, p_{max} - Hertz pressure max.

$$p_m = \frac{1}{\pi} \sqrt{\frac{6 \cdot N \cdot \frac{1}{r_k^2}}{\left(\frac{1-\nu_1^2}{E_1} + \frac{1-\nu_2^2}{E_2}\right)^2}} \tag{1}$$

where: ν - Poisson ratio, E - Young's modulus, N - axial force, r_o - contact radius, r_k - sphere radius.

Pivoting friction is created by continuous rotary motion or gyroscopic motion around normal in the point of contact between two co-operating surfaces. In the paper try analyzed pivoting friction conditions for flat surface – spherical cap model type (figure 2).

3. Research object

Moveable connection (kinematic pair) enabling the rotatory oscillate movement of the one connected component in relation to the second element are ball joint named. The axis pass through the ball joint, round which takes the place the turn of wheel in moment of turn the steering gear of vehicle by driver. Additionally the ball joint enable the angle deflection and transmit the shearing and longitudinal forces (along the ball joint axis). Because in the time of work ball joints performs swing-rotational movement, they are lubricated by solid oil by grease nipple or by graphite grease when the ball joint construction are knead by machinery in housing. Build and description of main components of ball joint shows figure 3.

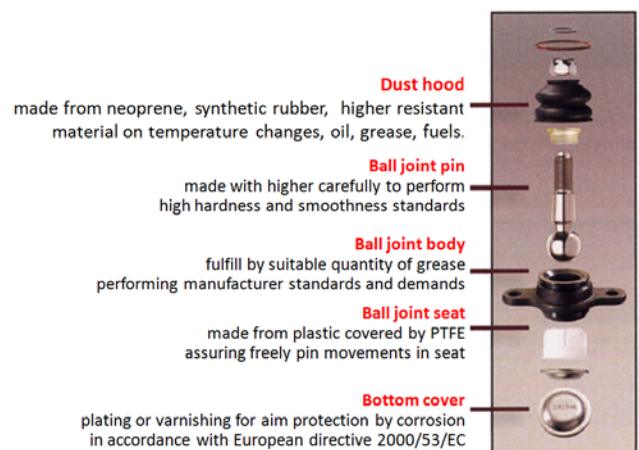

Fig. 3 Build and description of the of ball joint elements [1].

The ball joints construction approach to minimize friction by polishing the pin of ball joints. The grease used inside and pin additionally covered by teflon are also contributed to smooth working and for fast reaction time. Dust hood are mainly made from neoprene (CR), which characterize protection to temperature changes, oil and fuel conditions and protection to variable weather conditions. Nylon insertion inside nut prevents forming among pin

and nut corrosion inside, as well as makes impossible coming unscrewed nut. The most often ball joints defects are: get inside water, sand and other foreign matter are result of faster wear mates elements in ball joints are effect of splitting rubber cover [2].

4. Test bench for determination friction coefficient

Figure 4 shows the test bench for determination friction coefficient by the string twist angle measurement.

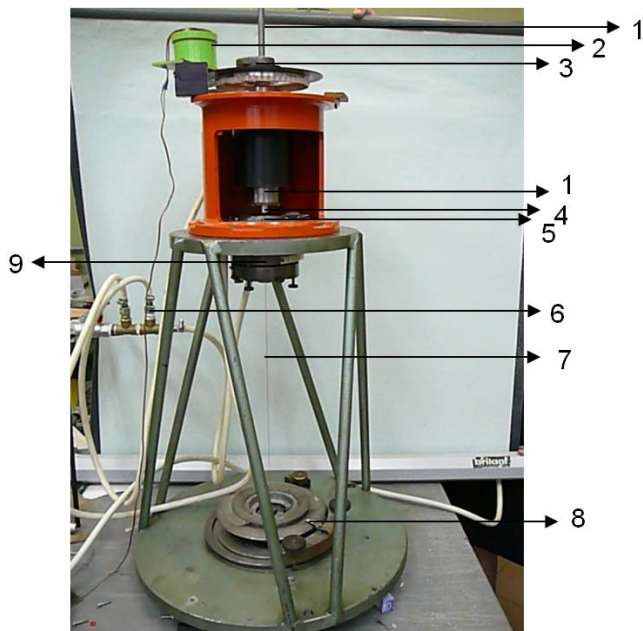

Fig. 4 Test bench for the friction moment and friction coefficient for the frictional pair ball joint – spherical cap; 1 – shaft, 2 – electric motor, 3 – weights, 4 – ball joint, 5 – tested ball joint, 6 – compressed air supply, 7 – string, 8 – disc to read the angle of torsion, 9 – aerostatic table [3].

The test bench are built from two cylindrical radial bearing and axial bearing. Drive from electric motor (2) are transferred between belt transmission on the shaft (1) which ended by the ball joint. The load of the researched friction pair is change by add weights (3) on the shaft (1). The tested ball joint (5) is placed on the aerostatic table (9) which is connected with string measurement (7). The second end of string is mounted to the table (8) which is used to twist string angle compensation. The angle of compensation is read from the scale plotted on the table (8).

5. Calibration of the strings

String patterns on a special measuring instrument bearings aerostatic (figure 5,6), placed on a table to eliminate external vibrations from the environment. Aerostatic fed bearing pressure of 10 bars. In order to obtain the actual value of the angle of torsion measurements made over ten series of successively burdening string weights G (figure 5) with a mass of about 2 g, 4 g, 6 g and 8 g (accurate mass values are given in the tables of measurement data). The arm weights of force was 50 mm. In this way data to calculate the torque and removal characteristics of the studied strings. The calculation results are presented graphically in charts 5 and 6 respectively for the strings 1 and 2. Constant strings calculated from the following equation.

$$k = \frac{P \cdot r}{\varphi} \tag{2}$$

Where k – constant of string, P – loading force, r – arm of a force, φ – torsional angle.

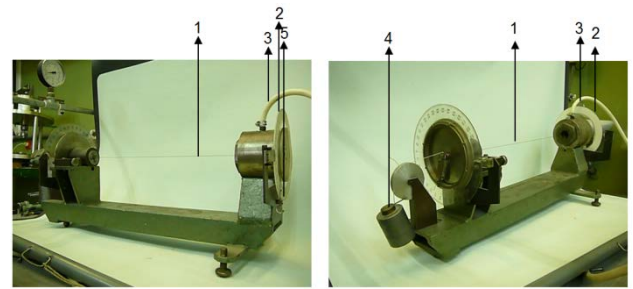

Fig. 5 The scheme of test bench for string calibration: 1 – string, 2 – disk for read torsional string angle, 3 – aerostatic bearing, 4 – weight for string load, 5 – the place for weights position.

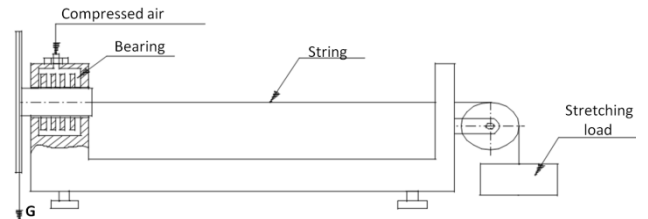

Fig. 6 The scheme of test bench for string calibration, where G is a load making string turns.

Analyzing the figures 7 and 8 can be seen that the real courses differ somewhat from the trend line, a line obtained by least mean squares defining characteristic. Differences may result from inaccuracies in reading the angle from the measuring instruments and an end to the phenomenon of coincidence measurement on the scale. A more accurate readings could be obtain by using the digital measuring instruments.

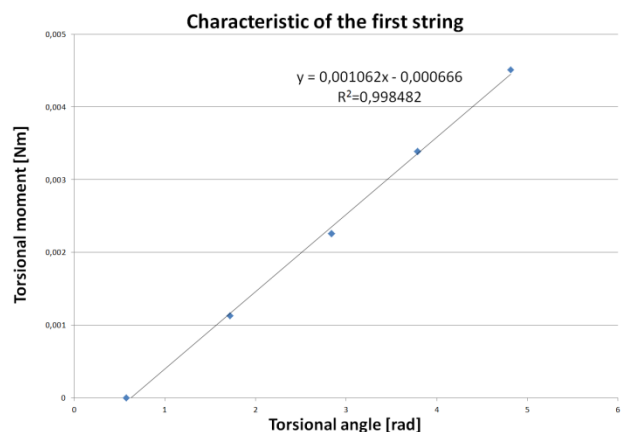

Fig. 7 Characteristic of the first string.

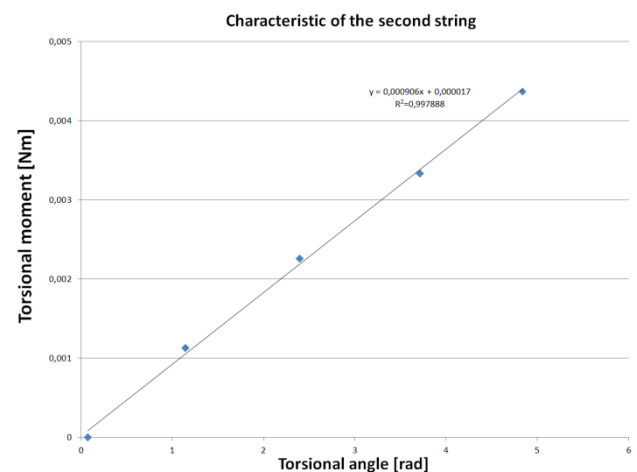

Fig. 8 Characteristic of the second string.

6. Comparison of friction coefficient for the test bench measurements and theoretical calculation

Bearing ball made from steel 100Cr6 with diameter 8mm and ball joint pin from steel were selected to researches. The ball joints selected to researches came from cars: Nissan Maxima (year of production 2008, mileage 185000km), Peugeot 206 (year of production 2007, mileage 95000km), Mercedes Sprinter (year of production 2005, mileage 230000km). All of the ball joints are mounted originally in mentioned cars. Described cars didn't pass the inspection on the diagnostic station for ball joints on the control arm reason.

Test bench researches lead by measure the torsional angle of the string in the loading function. The electric motor was started after mounted the ball joint and measure ball on the test bench. The measurement shaft with ball rotated with constant speed – 36 rpm. Then the test bench was step loaded by 2 N in the range 7,09÷16,9N. After that the test bench was lightened in inversely sequence. Weights were added for 500 cycles. Figure 9 shows the curves of the friction coefficient with approximation equations for the listed cars. Table 1 shows values of the friction coefficient.

- Pawelski Z., Woźniak M., Zakrzewski S., Józwiak P., Ozuna G., De La Fuente P.: *Badania stanowiskowe przegubów kulistych z wykorzystaniem mikroskopu skaningowego*. Technika Transportu Szynowego (TTS), 9/2012, s. 2825-2831,
- Wozniak M., Ozuna G., De La Fuente P., Jozwiak P., Pawelski Z.: *Comparison of researches of friction coefficient in concentrated contact for the stress: steel-steel and steel-magnesium alloys*. International Virtual Journal for Science, Technics and Innovations for the Industry MTM. Year VI, Issue 6/2013, pp.51-54, Bulgaria, 1-2.07.2013,
- Burcan J.: *Analiza oporów ruchu i jej wykorzystanie w projektowaniu drobnych mechanizmów precyzyjnych*. Zeszyty Naukowe nr. 546, Politechnika Łódzka, Łódź, 1989.

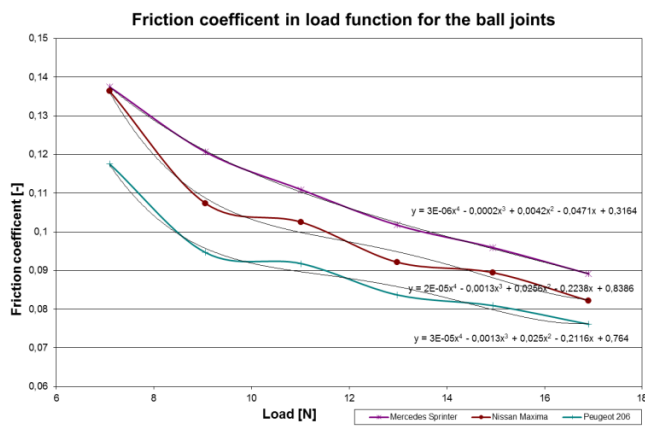

Fig. 9 Friction coefficient in load function for Nissan Maxima (green), Peugeot 206 (red) and Mercedes Sprinter (purple)

Tab.1 Values of friction coefficient and P_{max} for selected cars.

Load [N]	P _{max} [Pa]	μ - Friction coefficient [-]		
		Mercedes Sprinter	Nissan Maxima	Peugeot 206
7,09	1,04E+09	0,13748	0,13638	0,11754
9,05	1,13E+09	0,12067	0,10739	0,09465
11,01	1,20E+09	0,11091	0,10251	0,09178
12,97	1,27E+09	0,10176	0,09216	0,08371
14,94	1,33E+09	0,09593	0,08946	0,08092
16,91	1,39E+09	0,08914	0,08218	0,07609

7. Conclusions

- Values of the friction coefficient decrease directly proportional with load increase.
- The character of friction coefficient course in load function for analytic determinate is near to experimental course assigned.
- Values of the friction coefficient read from the scale plotted on the table allow plastic strain.
- Differences of friction coefficient for analytic calculations and from experimental don't cross 0,0025 in whole load range.

8. References

- Wozniak M., Ozuna G., De La Fuente P., Jozwiak P., Pawelski Z.: *Test bench with AFM and STM modules for wear researches passengers car suspensions elements*. International Virtual Journal for Science, Technics and Innovations for the Industry MTM. Year VI, Issue 4/2012, pp.9-11, Bulgaria, 27-29.06.2012,